

**Description**

The DigiFlex® Performance™ (DP) Series digital servo drives are designed to drive brushed and brushless servomotors. These fully digital drives operate in torque, velocity, or position mode and employ Space Vector Modulation (SVM), which results in higher bus voltage utilization and reduced heat dissipation compared to traditional PWM. The drive can be configured for a variety of external command signals. Commands can also be configured using the drive's built-in Motion Engine, an internal motion controller used with distributed motion applications. In addition to motor control, these drives feature dedicated and programmable digital and analog inputs and outputs to enhance interfacing with external controllers and devices.

Network communication is accomplished using either RS-485/232 or Modbus RTU. This DP Series drive features a single serial interface used for drive commissioning via DriveWare® 7, available for download at [www.a-m-c.com](http://www.a-m-c.com).

The DPR Hardware Installation Manual is available for download from [www.a-m-c.com](http://www.a-m-c.com). All drive and motor parameters are stored in non-volatile memory.

**Power Range**

Peak Current	60 A (42.4 A <sub>RMS</sub> )
Continuous Current	30 A (30 A <sub>RMS</sub> )
Supply Voltage	20 - 80 VDC



**Features**

- ▲ Four Quadrant Regenerative Operation
- ▲ Space Vector Modulation (SVM) Technology
- ▲ Fully Digital State-of-the-art Design
- ▲ Programmable Gain Settings
- ▲ Fully Configurable Current, Voltage, Velocity and Position Limits
- ▲ PIDF Velocity Loop
- ▲ PID + FF Position Loop
- ▲ Compact Size, High Power Density
- ▲ 16-bit Analog to Digital Hardware
- ▲ On-the-Fly Mode Switching
- ▲ On-the-Fly Gain Set Switching

**MODES OF OPERATION**

- Current
- Position
- Velocity

**COMMAND SOURCE**

- ±10 V Analog
- 5V Step and Direction
- Encoder Following
- Over the Network
- Sequencing
- Indexing
- Jogging

**FEEDBACK SUPPORTED**

- Resolver
- ±10 VDC Position
- Auxiliary Incremental Encoder
- Tachometer (±10 VDC)

**INPUTS/OUTPUTS**

- 3 Programmable Analog Inputs (16-bit/12-bit Resolution)
- 2 Programmable Analog Outputs (10-bit Resolution)
- 2 Programmable Digital Inputs (Differential)
- 4 Programmable Digital Inputs (Single-Ended)
- 4 Programmable Digital Outputs (Single-Ended)



**COMPLIANCES & AGENCY APPROVALS**

- UL
- cUL
- CE Class A (LVD)
- CE Class A (EMC)
- RoHS II

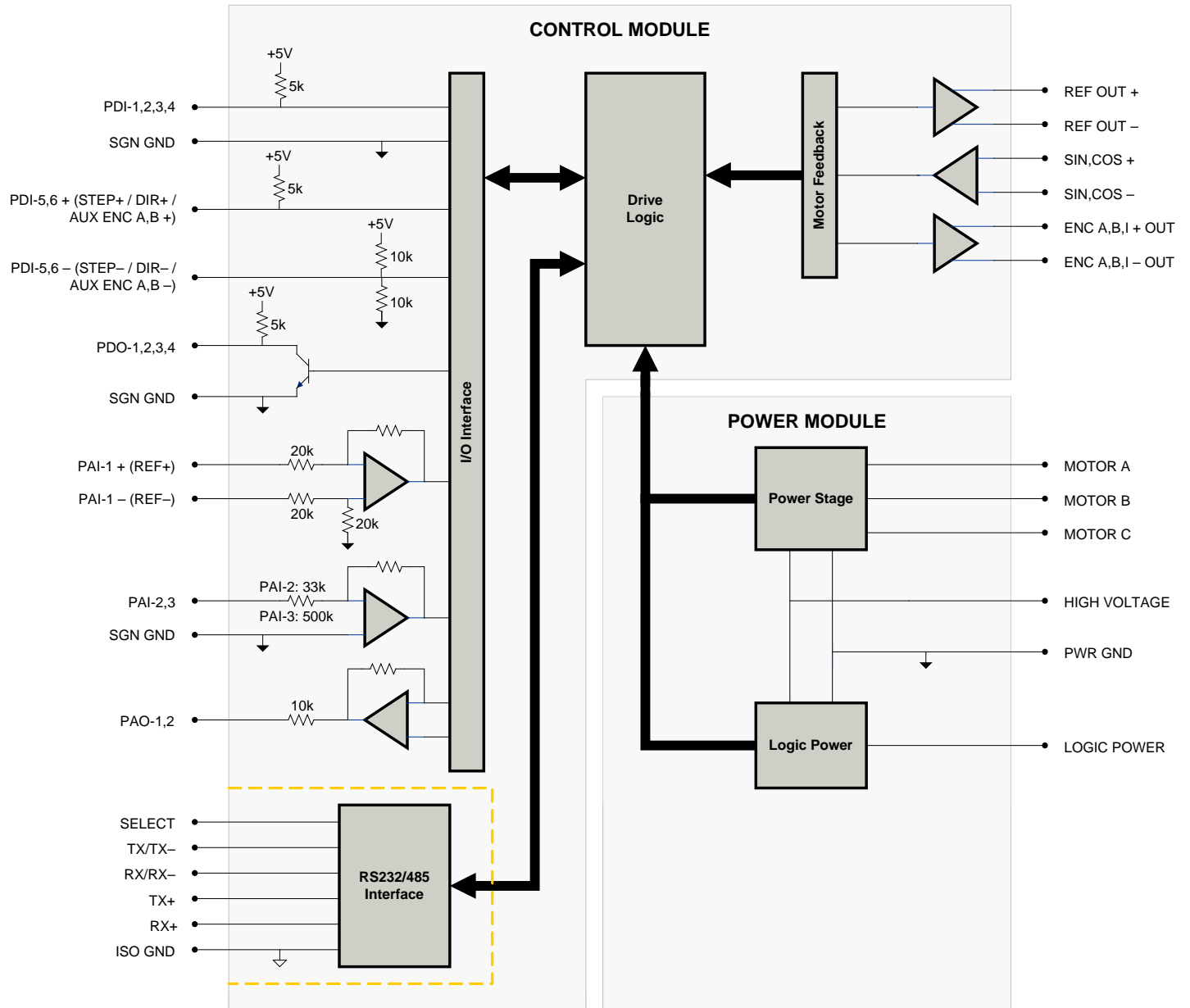
**BLOCK DIAGRAM**



**Information on Approvals and Compliances**

	<p>US and Canadian safety compliance with UL 508c, the industrial standard for power conversion electronics. UL registered under file number E140173. Note that machine components compliant with UL are considered UL registered as opposed to UL listed as would be the case for commercial products.</p>
	<p>Compliant with European EMC Directive 2004/108/EC on Electromagnetic Compatibility (specifically EN 61000-6-4:2007 for Emissions, Class A and EN 61000-6-2:2005 for Immunity, Performance Criteria A). LVD requirements of Directive 2006/95/EC (specifically, EN 60204-1:2004, a Low Voltage Directive to protect users from electrical shock).</p>
	<p>The RoHS II Directive 2011/65/EU restricts the use of certain substances including lead, mercury, cadmium, hexavalent chromium and halogenated flame retardants PBB and PBDE in electronic equipment.</p>

**SPECIFICATIONS**

Description		Power Specifications	
		Units	Value
DC Supply Voltage Range		VDC	20 - 80
DC Bus Over Voltage Limit		VDC	88.7
DC Bus Under Voltage Limit		VDC	17.5
Logic Supply Voltage		VDC	20 - 80
Maximum Peak Output Current <sup>1</sup>		A (Arms)	60 (42.4)
Maximum Continuous Output Current <sup>2</sup>		A (Arms)	30 (30)
Maximum Continuous Output Power		W	2280
Maximum Power Dissipation at Continuous Current		W	120
Internal Bus Capacitance		µF	500
Minimum Load Inductance (Line-To-Line) <sup>3</sup>		µH	250 (at 80 V supply); 150 (at 48 V supply); 75 (at 24 V supply)
Switching Frequency		kHz	20
Maximum Output PWM Duty Cycle		%	100
Low Voltage Supply Outputs		-	+5 VDC (250 mA)
Description		Control Specifications	
		Units	Value
Communication Interfaces		-	RS-485/232 / Modbus RTU
Command Sources		-	±10 V Analog, 5V Step and Direction, Encoder Following, Over the Network, Sequencing, Indexing, Jogging
Feedback Supported		-	±10 VDC Position, Auxiliary Incremental Encoder, Resolver, Tachometer (±10 VDC)
Commutation Methods		-	Sinusoidal
Modes of Operation		-	Current, Position, Velocity
Motors Supported		-	Closed Loop Vector, Single Phase (Brushed, Voice Coil, Inductive Load), Three Phase (Brushless)
Hardware Protection		-	40+ Configurable Functions, Over Current, Over Temperature (Drive & Motor), Over Voltage, Short Circuit (Phase-Phase & Phase-Ground), Under Voltage
Programmable Digital Inputs/Outputs (PDIs/PDOs)		-	6/4
Programmable Analog Inputs/Outputs (PAIs/PAOs)		-	3/2
Primary I/O Logic Level		-	5V TTL
Current Loop Sample Time		µs	50
Velocity Loop Sample Time		µs	100
Position Loop Sample Time		µs	100
Resolver Reference/Excitation Signal		Vrms	4 Vrms @ 5 kHz
Expected Resolver Transformation Ratio		Vrms	0.5
Feedback Resolution / Emulated Encoder Resolution <sup>4</sup>		bit	High Res: 14 (16384 counts/resolver cycle), Low Res: 12 (4096 counts/resolver cycle)
Maximum Motor Speed Per Feedback Resolution		RPM	High Res: 5000, Low Res: 20000
Description		Mechanical Specifications	
		Units	Value
Agency Approvals		-	CE Class A (EMC), CE Class A (LVD), cUL, RoHS II, UL
Size (H x W x D)		mm (in)	190.5 x 111.8 x 35.9 (7.5 x 4.4 x 1.4)
Weight		g (oz)	863 (30.4)
Heatsink (Base) Temperature Range <sup>5</sup>		°C (°F)	0 - 75 (32 - 167)
Storage Temperature Range		°C (°F)	-40 - 85 (-40 - 185)
Form Factor		-	Panel Mount
Cooling System		-	Natural Convection
IP Rating		-	IP10
COMM Connector		-	9-pin, female D-sub
FEEDBACK Connector		-	15-pin, high-density, female D-sub
I/O Connector		-	26-pin, high-density, female D-sub
MOTOR POWER Connector		-	3-port, 7.62 mm spaced, enclosed, friction lock header
POWER Connector		-	4-port, 7.62 mm spaced, enclosed, friction lock header

**Notes**

1. Capable of supplying drive rated peak current for 2 seconds with 10 second foldback to continuous value. Longer times are possible with lower current limits.
2. Continuous  $A_{rms}$  value attainable when RMS Charge-Based Limiting is used.
3. Lower inductance is acceptable for bus voltages well below maximum. Use external inductance to meet requirements.
4. Higher and lower resolution options are available. Contact Applications Engineering for more information.
5. Additional cooling and/or heatsink may be required to achieve rated performance.

**PIN FUNCTIONS**

<b>COMM - RS232/RS485 Communication Connector</b>			
Pin	Name	Description / Notes	I/O
1	SELECT	RS232/485 selection. Pull to ground (CN1-5) for RS485.	I
2	RS232 TX / RS485 TX-	Transmit Line (RS-232 or RS-485)	O
3	RS232 RX / RS485 RX-	Receive Line (RS-232 or RS-485)	I
4	RESERVED	Reserved	-
5	ISO GND	Isolated Signal Ground	IGND
6	RS485 TX+	Transmit Line (RS-485)	O
7	RESERVED	Reserved	-
8	RS485 RX+	Receive Line (RS-485)	I
9	RESERVED	Reserved	-

<b>FEEDBACK - Feedback Connector</b>			
Pin	Name	Description / Notes	I/O
1	RESERVED	Reserved	-
2	RESERVED	Reserved	-
3	RESERVED	Reserved	-
4	REF OUT +	Resolver Reference/Excitation Output	O
5	REF OUT -		O
6	SIN+	Resolver Sine Input	I
7	SIN-		I
8	COS+	Resolver Cosine Input	I
9	COS-		I
10	RESERVED	Reserved	-
11	RESERVED	Reserved	-
12	SGN GND	Signal Ground	SGND
13	+5V OUT	+5V Encoder Supply Output (Short Circuit Protected)	O
14	PAI-3	Programmable Analog Input (12-bit Resolution)	I
15	RESERVED	Reserved	-

<b>I/O - Signal Connector</b>			
Pin	Name	Description / Notes	I/O
1	PDO-1	Programmable Digital Output	O
2	SGN GND	Signal Ground	SGND
3	PDO-2	Programmable Digital Output	O
4	PAI-1 + (REF+)	Differential Programmable Analog Input or Reference Signal Input (16-bit Resolution)	I
5	PAI-1 - (REF-)		I
6	PAI-2	Programmable Analog Input (12-bit Resolution)	I
7	PAO-1	Programmable Analog Output (10-bit Resolution)	O
8	PAO-2	Programmable Analog Output (10-bit Resolution)	O
9	PDI-6 - (DIR- / AUX ENC B-)	Programmable Digital Input or Direction- or Auxiliary Encoder (For Differential Signals Only)	I
10	PDO-3		O
11	PDI-1	Programmable Digital Input	I
12	PDI-2	Programmable Digital Input	I
13	PDI-3	Programmable Digital Input	I
14	PDO-4	Programmable Digital Output	O
15	+5V OUT	+5V Encoder Supply Output (Short Circuit Protected)	O
16	SGN GND	Signal Ground	SGND
17	PDI-5 + (STEP+ / AUX ENC A+)	Programmable Digital Input or Step+ or Auxiliary Encoder	I
18	PDI-6 + (DIR+ / AUX ENC B+)		I
19	PDI-4	Programmable Digital Input	I
20	ENC A+ OUT	Emulated Encoder Channel A Output	O
21	ENC A- OUT		O
22	ENC B+ OUT	Emulated Encoder Channel B Output	O
23	ENC B- OUT		O
24	ENC I+ OUT	Emulated Encoder Index Output	O
25	ENC I- OUT		O
26	PDI-5 - (STEP- / AUX ENC A-)	Programmable Digital Input or Step- or Auxiliary Encoder (For Differential Signals Only)	I

<b>MOTOR POWER - Power Connector</b>			
Pin	Name	Description / Notes	I/O
1	MOTOR A	Motor Phase A	O
2	MOTOR B	Motor Phase B	O
3	MOTOR C	Motor Phase C	O

POWER - Power Connector			
Pin	Name	Description / Notes	I/O
1	PWR GND	Power Ground (Common With Signal Ground)	PGND
2	HIGH VOLTAGE	DC Power Input	I
3	LOGIC GND	Logic Supply Ground (Common With Signal Ground)	GND
4	LOGIC PWR	Logic Supply Input	I

## HARDWARE SETTINGS

### Switch Functions

Switch	Description	Setting	
		On	Off
1	Bit 0 of binary RS-485 drive address. Does not affect RS-232 settings.	1	0
2	Bit 1 of binary RS-485 drive address. Does not affect RS-232 settings.	1	0
3	Bit 2 of binary RS-485 drive address. Does not affect RS-232 settings.	1	0
4	Bit 3 of binary RS-485 drive address. Does not affect RS-232 settings.	1	0
5	Bit 4 of binary RS-485 drive address. Does not affect RS-232 settings.	1	0
6	Bit 5 of binary RS-485 drive address. Does not affect RS-232 settings.	1	0
7	Bit 0 of drive RS-485 baud rate setting. Does not affect RS-232 settings.	1	0
8	Bit 1 of drive RS-485 baud rate setting. Does not affect RS-232 settings.	1	0

#### Additional Details

The drive can be configured to use the address and/or bit rate stored in non-volatile memory by setting the address and/or bit rate value to 0. Use the table below to map actual bit rates to a bit rate setting.

Baud Rate (kbps)	Value For Bit Rate Setting
Load from non-volatile memory	0
9.6	1
38.4	2
115.2	3

**MECHANICAL INFORMATION**

**COMM - RS232/RS485 Communication Connector**

Connector Information		9-pin, female D-sub
Mating Connector	Details	TYCO: Plug P/N 205204-4; Housing P/N 5748677-1; Terminals P/N 1658540-5 (loose) or 1658540-4 (strip)
	Included with Drive	No

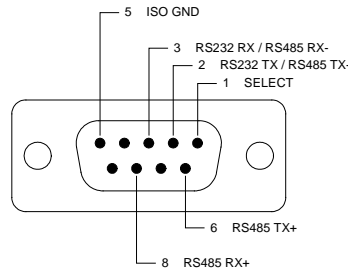

**FEEDBACK - Feedback Connector**

Connector Information		15-pin, high-density, female D-sub
Mating Connector	Details	TYCO: Plug P/N 748364-1; Housing P/N 5748677-1; Terminals P/N 1658670-2 (loose) or 1658670-1 (strip)
	Included with Drive	No

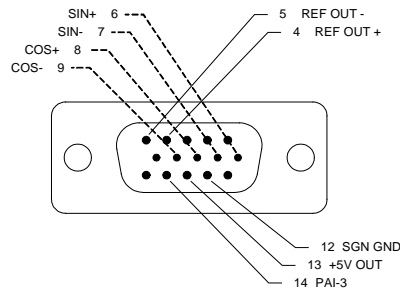

**I/O - Signal Connector**

Connector Information	26-pin, high-density, female D-sub	
Mating Connector	Details	TYCO: Plug P/N 1658671-1; Housing P/N 5748677-2; Terminals P/N 1658670-2 (loose) or 1658670-1 (strip)
	Included with Drive	No

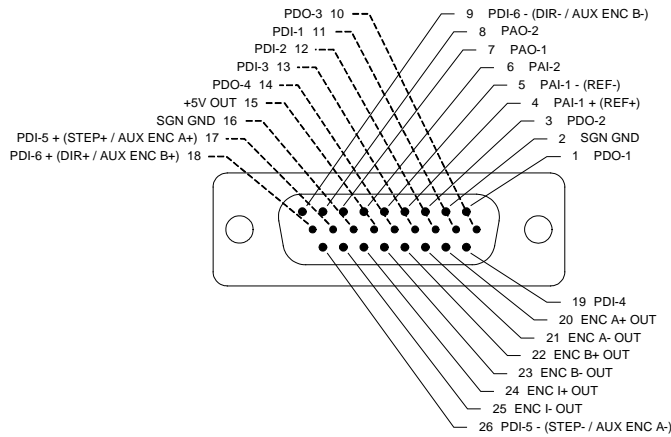

**MOTOR POWER - Power Connector**

Connector Information	3-port, 7.62 mm spaced, enclosed, friction lock header	
Mating Connector	Details	Phoenix Contact: P/N 1804917
	Included with Drive	Yes

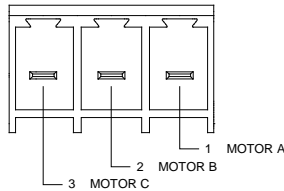

**POWER - Power Connector**

Connector Information	4-port, 7.62 mm spaced, enclosed, friction lock header	
Mating Connector	Details	Phoenix Contact: P/N 1804920
	Included with Drive	Yes

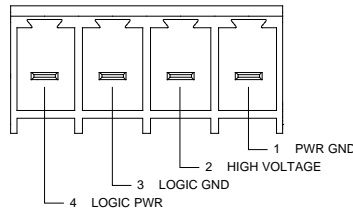

**MOUNTING DIMENSIONS**

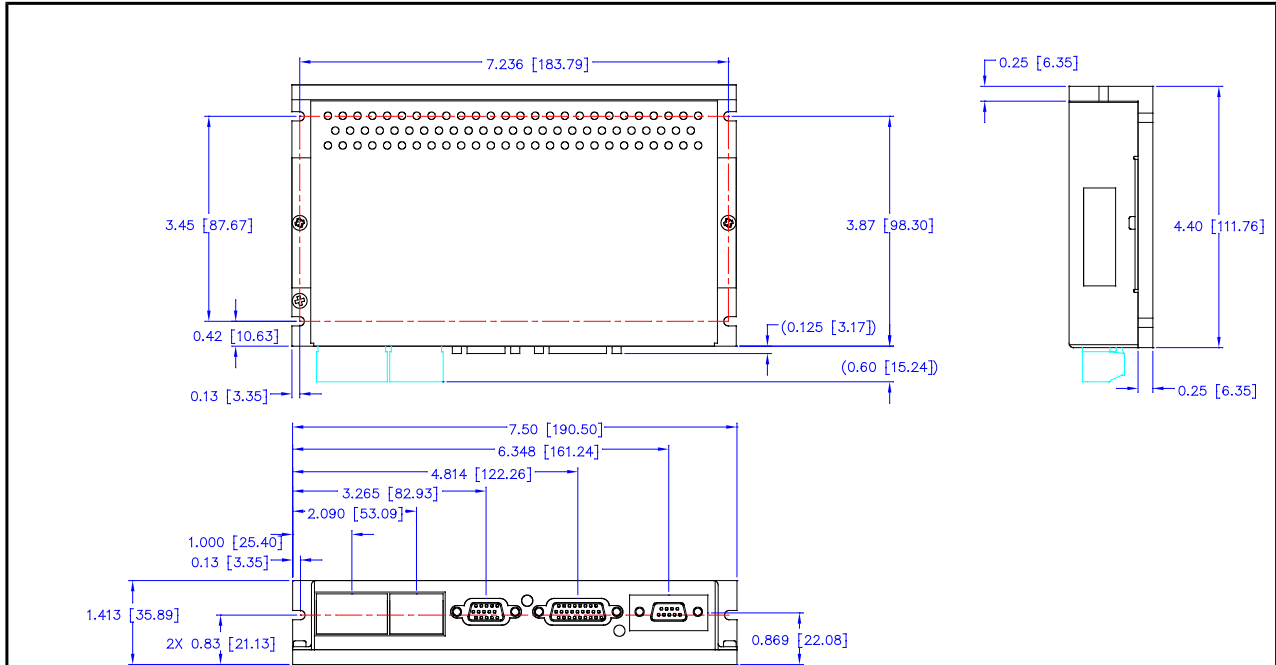

1. DIMENSION IN [ ] ARE MM.

NOTES: UNLESS OTHERWISE SPECIFIED

REV	DESCRIPTION	DATE	BY	ECO
A	INITIAL RELEASE	07/17/08	PM	

  

UNLESS OTHERWISE SPECIFIED: DIMENSIONS ARE IN INCHES TOLERANCES .XX ± .010 .XXX ± .005 DO NOT SCALE DRAWING		 PWM SERVO AMPLIFIERS 3805 Calle Tecate, Camarillo, CA 93012	
DRAWN BY: R. BAUTISTA		DATE: 08/03/07	
CHECK BY:		DATE:	
DESIGN APPROVED:		DATE:	
USED ON		TITLE MOUNTING DIMENSIONS, DPRALTx-060B080	SIZE C
		DWG. NO. MDDPR060B080	REV A
		SCALE: FULL	SHT. 1 OF 1



**PART NUMBERING INFORMATION**

Example: **D P R A L T R - 0 6 0 B 0 8 0 -**

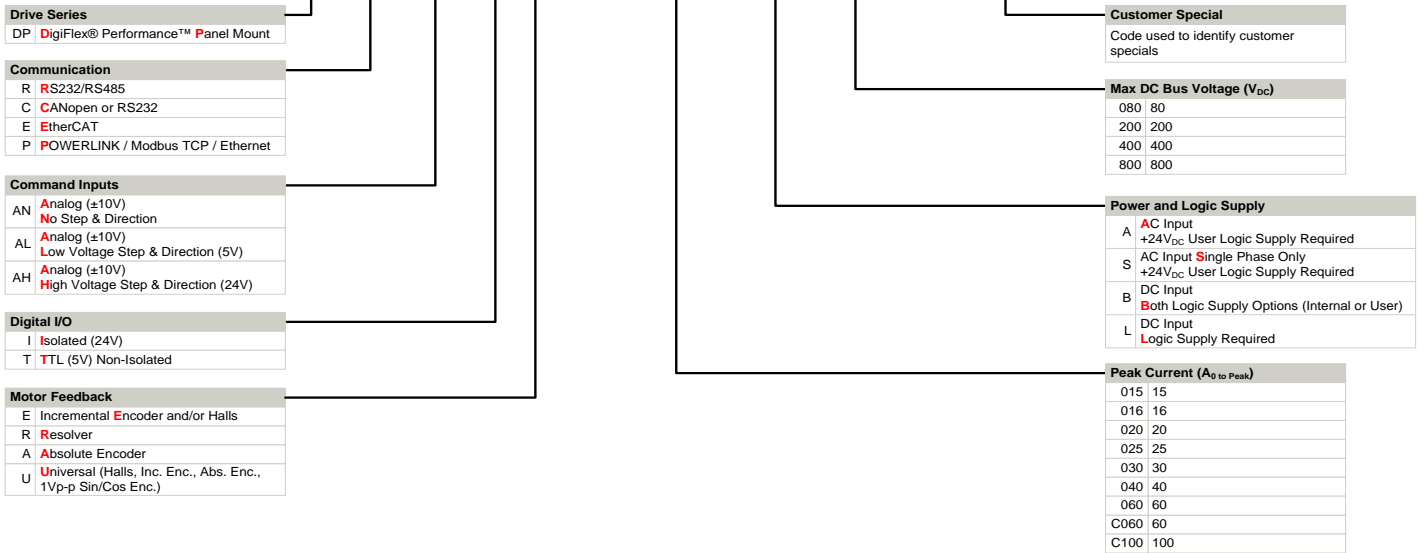

DigiFlex® Performance™ series of products are available in many configurations. Note that not all possible part number combinations are offered as standard drives. All models listed in the selection tables of the website are readily available, standard product offerings.

ADVANCED Motion Controls also has the capability to promptly develop and deliver specified products for OEMs with volume requests. Our Applications and Engineering Departments will work closely with your design team through all stages of development in order to provide the best servo drive solution for your system. Equipped with on-site manufacturing for quick-turn customs capabilities, ADVANCED Motion Controls utilizes our years of engineering and manufacturing expertise to decrease your costs and time-to-market while increasing system quality and reliability. Feel free to contact Applications Engineering for further information and details.

**Examples of Customized Products**

- ▲ Optimized Footprint
- ▲ Private Label Software
- ▲ OEM Specified Connectors
- ▲ No Outer Case
- ▲ Increased Current Resolution
- ▲ Increased Temperature Range
- ▲ Custom Control Interface
- ▲ Integrated System I/O
- ▲ Tailored Project File
- ▲ Silkscreen Branding
- ▲ Optimized Base Plate
- ▲ Increased Current Limits
- ▲ Increased Voltage Range
- ▲ Conformal Coating
- ▲ Multi-Axis Configurations
- ▲ Reduced Profile Size and Weight

**Available Accessories**

ADVANCED Motion Controls offers a variety of accessories designed to facilitate drive integration into a servo system. Visit [www.a-m-c.com](http://www.a-m-c.com) to see which accessories will assist with your application design and implementation.



All specifications in this document are subject to change without written notice. Actual product may differ from pictures provided in this document.