

Description

The DigiFlex® Performance™ (DP) Series digital servo drives are designed to drive brushed and brushless servomotors. These fully digital drives operate in torque, velocity, or position mode and employ Space Vector Modulation (SVM), which results in higher bus voltage utilization and reduced heat dissipation compared to traditional PWM. The command source can be generated internally or can be supplied externally. In addition to motor control, these drives feature dedicated and programmable digital and analog inputs and outputs to enhance interfacing with external controllers and devices.

This DP Series drive features an Ethernet interface for network communication using Ethernet POWERLINK, Modbus TCP or Ethernet, and a USB port for drive commissioning using DriveWare® 7, available for download at www.a-m-c.com.

All drive and motor parameters are stored in non-volatile memory. The DPP Series Hardware Installation Manual is available for download at www.a-m-c.com.

Power Range

Peak Current	15 A (10.6 A _{RMS})
Continuous Current	7.5 A (7.5 A _{RMS})
Supply Voltage	100 - 240 VAC

 ETHERNET
POWERLINK

Ethernet
Features

- ▲ Four Quadrant Regenerative Operation
- ▲ Space Vector Modulation (SVM) Technology
- ▲ Fully Digital State-of-the-art Design
- ▲ Programmable Gain Settings
- ▲ Fully Configurable Current, Voltage, Velocity and Position Limits
- ▲ PIDF Velocity Loop
- ▲ PID + FF Position Loop
- ▲ Compact size, high power density
- ▲ 16-bit Analog to Digital Hardware
- ▲ Built-in brake/shunt regulator
- ▲ On-the-Fly Mode Switching
- ▲ On-the-Fly Gain Set Switching
- ▲ Dedicated Safe Torque Off (STO) Inputs

MODES OF OPERATION

- Profile Modes
- Cyclic Synchronous Modes
- Current
- Velocity
- Position

COMMAND SOURCE

- ±10 V Analog
- Encoder Following
- Over the Network
- Sequencing
- Indexing
- Jogging

FEEDBACK SUPPORTED (FIRMWARE DEPENDENT)

- Halls
- Incremental Encoder
- Absolute Encoder (EnDat® 2.1/2.2, Hiperface®, or BiSS C-Mode)
- 1Vp-p Sine/Cosine Encoder
- Auxiliary Incremental Encoder
- Tachometer (±10 VDC)

INPUTS/OUTPUTS

- 1 Motor Thermistor/Switch Input
- 11 General Purpose Programmable Digital Inputs
- 1 High Speed Programmable Digital Output
- 6 General Purpose Programmable Digital Outputs
- 2 Programmable Analog Inputs



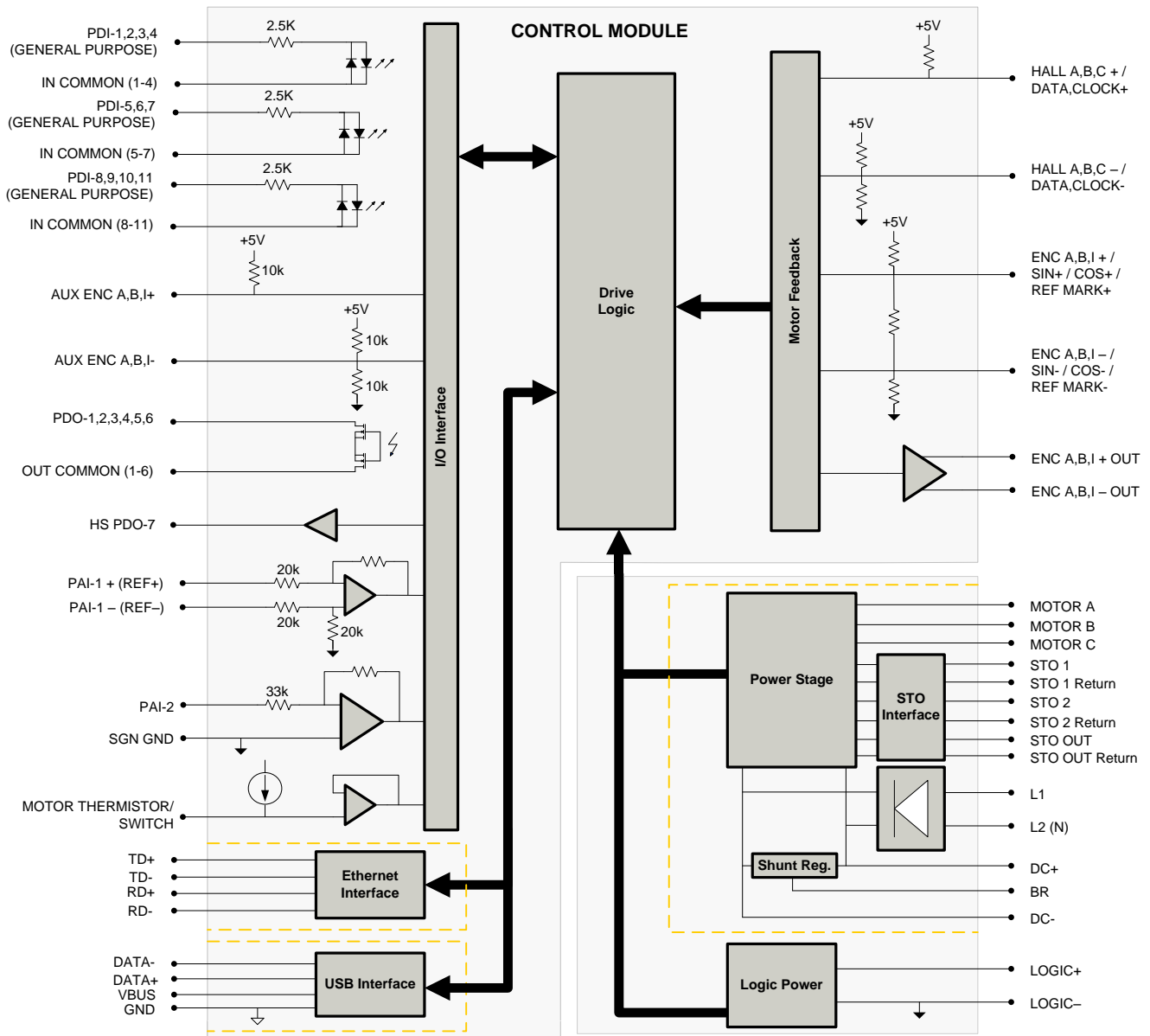

COMPLIANCES & AGENCY APPROVALS

- UL
- cUL
- CE Class A (LVD)
- CE Class A (EMC)
- RoHS II
- TÜV Rheinland® (STO)

BLOCK DIAGRAM



Information on Approvals and Compliances

	<p>US and Canadian safety compliance with UL 508c, the industrial standard for power conversion electronics. UL registered under file number E140173. Note that machine components compliant with UL are considered UL registered as opposed to UL listed as would be the case for commercial products.</p>
	<p>Compliant with European EMC Directive 2014/30/EU on Electromagnetic Compatibility (specifically EN 61000-6-4:2007/A1:2011 for Emissions, Class A and EN 61000-6-2:2005 for Immunity, Performance Criteria A). LVD requirements of Directive 2014/35/EU (specifically, EN 60204-1:2006/A1:2009, a Low Voltage Directive to protect users from electrical shock).</p>
	<p>The RoHS II Directive 2011/65/EU restricts the use of certain substances including lead, mercury, cadmium, hexavalent chromium and halogenated flame retardants PBB and PBDE in electronic equipment.</p>
	<p>Functional Safety STO is TÜV Rheinland® certified and meets requirements of the following standards:</p> <ul style="list-style-type: none"> • EN ISO 13849-1 Category 4 / PL e • EN IEC 61800-5-2 STO (SIL 3) • EN62061 SIL CL3 • IEC 61508 SIL 3

SPECIFICATIONS

Power Specifications		
Description	Units	Value
Rated Voltage	VAC (VDC)	240 (339)
AC Supply Voltage Range	VAC	100 – 240
AC Supply Minimum	VAC	90
AC Supply Maximum	VAC	264
AC Input Phases	-	1
AC Supply Frequency	Hz	50 – 60
DC Supply Voltage Range ¹	VDC	127 – 373
DC Bus Over Voltage Limit	VDC	394
DC Bus Under Voltage Limit	VDC	55
Logic Supply Voltage	VDC	20 – 30 (@ 850 mA)
Safe Torque Off Voltage	VDC	24 (±6)
Maximum Peak Output Current ²	A (A _{RMS})	15 (10.6)
Maximum Continuous Output Current ³	A (A _{RMS})	7.5 (7.5)
Maximum Continuous Power @ Rated Voltage ⁴	W	2415
Maximum Continuous Power Dissipation @ Rated Voltage	W	127
Internal Bus Capacitance	µF	540
External Shunt Resistor Minimum Resistance ⁵	Ω	25
Minimum Load Inductance (Line-To-Line) ⁵	µH	600
Switching Frequency	kHz	20
Maximum Output PWM Duty Cycle	%	100
Low Voltage Supply Outputs	-	+5 VDC (250 mA)
Control Specifications		
Description	Units	Value
Communication Interfaces	-	Ethernet POWERLINK / Modbus TCP / Ethernet (USB for Configuration)
Command Sources	-	±10 V Analog, Encoder Following, Over the Network, Sequencing, Indexing, Jogging
Feedback Supported	-	Halls, Incremental Encoder, Absolute Encoder (EnDat® 2.1/2.2, Hiperface®, or BiSS C-Mode), 1Vp-p Sine/Cosine Encoder, Auxiliary Incremental Encoder, Tachometer (±10 VDC)
Commutation Methods	-	Sinusoidal, Trapezoidal
Modes of Operation	-	Profile Modes, Cyclic Synchronous Modes, Current, Velocity, Position
Motors Supported	-	Closed Loop Vector, Single Phase (Brushed, Voice Coil, Inductive Load), Three Phase (Brushless)
Hardware Protection	-	40+ Configurable Functions, Over Current, Over Temperature (Drive & Motor), Over Voltage, Short Circuit (Phase-Phase & Phase-Ground), Under Voltage
Programmable Digital Inputs/Outputs (PDIs/PDOs)	-	11/7
Programmable Analog Inputs/Outputs (PAIs/PAOs)	-	2/0
Primary I/O Logic Level	-	24 VDC
Current Loop Sample Time	µs	50
Velocity Loop Sample Time	µs	100
Position Loop Sample Time	µs	100
Maximum Sin/Cos Encoder Frequency	kHz	200
Maximum Sin/Cos Interpolation	-	2048 counts per sin/cos cycle
Internal Shunt Regulator	-	Yes
Internal Shunt Resistor	-	No
Mechanical Specifications		
Description	Units	Value
Agency Approvals	-	CE Class A (EMC), CE Class A (LVD), cUL, RoHS II, TÜV Rheinland® (STO), UL
Size (H x W x D)	mm (in)	177.50 x 123.39 x 44.45 (6.99 x 4.86 x 1.75)
Weight	g (oz)	894 (31.5)
Heatsink (Base) Temperature Range ⁷	°C (°F)	0 - 75 (32 - 167)
Storage Temperature Range	°C (°F)	-40 - 85 (-40 - 185)
Cooling System	-	Natural Convection
Form Factor	-	Panel Mount
AUX. COMM Connector	-	5-pin, Mini USB B Type port
COMM Connector	-	Shielded, dual RJ-45 socket with LEDs
FEEDBACK Connector	-	15-pin, high-density, female D-sub
AUX. ENCODER Connector	-	15-pin, high-density, male D-sub
I/O Connector	-	26-pin, high-density, female D-sub
+24V LOGIC Connector	-	2-port, 3.5 mm spaced insert connector
POWER Connector	-	10-port, 5.08 mm spaced, enclosed, friction lock header
STO Connector	-	8-port, 2.0 mm spaced, enclosed, friction lock header

Notes

1. Large inrush current may occur upon initial DC supply connection to DC Bus.
2. Capable of supplying drive rated peak current for 2 seconds with 10 second foldback to continuous value. Longer times are possible with lower current limits.
3. Continuous A_{RMS} value attainable when RMS Charge-Based Limiting is used.
4. P = (DC Rated Voltage) * (Cont. RMS Current) * 0.95
5. ADVANCED Motion Controls recommends using an external fuse in series with the shunt resistor. A 3 amp motor delay fuse is typical.
6. Lower inductance is acceptable for bus voltages well below maximum. Use external inductance to meet requirements.
7. Additional cooling and/or heatsink may be required to achieve rated performance.

PIN FUNCTIONS

COMM – Ethernet Communication Connector				
Pin	Name	Description / Notes		I/O
1	RD+	Receiver + (100Base-TX)		I
2	RD-	Receiver - (100Base-TX)		I
3	TD+	Transmitter + (100Base-TX)		O
4	RESERVED	-		-
5	RESERVED	-		-
6	TD-	Transmitter - (100Base-TX)		O
7	RESERVED	-		-
8	RESERVED	-		-
9	RESERVED	-		-

I/O – Signal Connector				
Pin	Name	Description / Notes		I/O
1	PDO-1	General Purpose Programmable Digital Output (120 mA maximum)		O
2	PDO-2	General Purpose Programmable Digital Output (120 mA maximum)		O
3	PDO-3	General Purpose Programmable Digital Output (120 mA maximum)		O
4	OUT COMMON	Digital Output Common (1-6)		OCOM
5	GROUND	Ground		GND
6	PDO-4	General Purpose Programmable Digital Output (120 mA maximum)		O
7	PDO-5	General Purpose Programmable Digital Output (120 mA maximum)		O
8	HS PDO-7	High Speed Programmable Digital Output		O
9	PDO-6	General Purpose Programmable Digital Output (120 mA maximum)		O
10	PDI-1	General Purpose Programmable Digital Input		I
11	PDI-2	General Purpose Programmable Digital Input		I
12	PDI-3	General Purpose Programmable Digital Input		I
13	PDI-4	General Purpose Programmable Digital Input		I
14	IN COMMON	Digital Input Common (1-4)		ICOM
15	IN COMMON	Digital Input Common (5-7)		ICOM
16	PDI-5	General Purpose Programmable Digital Input		I
17	PDI-6	General Purpose Programmable Digital Input		I
18	PDI-7	General Purpose Programmable Digital Input		I
19	PDI-8	General Purpose Programmable Digital Input		I
20	PDI-9	General Purpose Programmable Digital Input		I
21	PDI-10	General Purpose Programmable Digital Input		I
22	PDI-11	General Purpose Programmable Digital Input		I
23	IN COMMON	Digital Input Common (8-11)		ICOM
24	PAI-1+	General Purpose Differential Programmable Analog Input or Reference Signal Input (16-bit Resolution)		I
25	PAI-1-			I
26	GROUND	Ground		GND

FEEDBACK – Feedback Connector*					
Pin	Incremental Encoder	Absolute Encoder	1Vp-p Sin/Cos Encoder	Description / Notes	I/O
1	HALL A+	DATA-	HALL A+	Differential Hall A+ / Differential Data Line (BiSS: SLO-)	I
2	HALL B+	CLOCK+	HALL B+		Differential Hall B+ / Differential Clock Line (BiSS: MA+)
3	HALL C+	N/C	HALL C+	Differential Hall C+	I
4	ENC A+	SIN +	SIN +	Differential Encoder A / Differential Sine Input (Leave open for BiSS and EnDat 2.2)	I
5	ENC A-	SIN -	SIN -		I
6	ENC B+	COS +	COS +	Differential Encoder B / Differential Cosine Input (Leave open for BiSS and EnDat 2.2)	I
7	ENC B-	COS -	COS -		I
8	ENC I+	REF MARK+	REF MARK +	Differential Encoder Index / Differential Reference Mark (Leave open for BiSS and EnDat 2.2)	I
9	ENC I-	REF MARK-	REF MARK -		I
10	HALL A-	DATA+	HALL A-	Differential Hall A- / Differential Data Line (BiSS: SLO+)	I
11	HALL B-	CLOCK-	HALL B-	Differential Hall B- / Differential Clock Line (BiSS: MA-)	I
12	SGND	SGND	SGND	5V Return (Signal Ground)	SGND
13	+5V OUT	+5V OUT	+5V OUT	+5V Encoder Supply Output. Short-circuit protected. (250mA)	O
14	THERMISTOR	THERMISTOR	THERMISTOR	Motor Thermal Protection	I
15	HALL C-	N/C	HALL C-	Differential Hall C-	I

*Note: Feedback supported (Incremental Encoder, Absolute Sin/Cos Encoder, or 1Vp-p Sin/Cos Encoder) will be dependent on firmware.

AUX. ENCODER – Auxiliary Encoder Connector

Pin	Name	Description / Notes	I/O
1	ENC A+ OUT / RESERVED	Buffered Encoder Channel A Output* or Reserved.	O
2	ENC A- OUT / RESERVED		O
3	ENC B+ OUT / RESERVED	Buffered Encoder Channel B Output* or Reserved.	O
4	AUX ENC A+		I
5	AUX ENC A-	Auxiliary Encoder Input (For single ended signal leave negative terminal open)	I
6	AUX ENC B+		I
7	AUX ENC B-	Auxiliary Encoder Input (For single ended signal leave negative terminal open)	I
8	AUX ENC I+		I
9	AUX ENC I-	Auxiliary Encoder Index Input (For single ended signal leave negative terminal open)	I
10	ENC B- OUT / RESERVED		O
11	ENC I+ OUT / RESERVED	Buffered Encoder Index Output* or Reserved.	O
12	SGND	Signal Ground	SGND
13	+5V OUT	+5 VDC User Supply	O
14	PAI-2	Programmable Analog Input (12-bit Resolution)	I
15	ENC I- OUT / RESERVED	Buffered Encoder Index Output* or Reserved.	O

*Buffered encoder output only available with incremental encoder or 1Vp-p sin/cos encoder feedbacks. 1:1 input-to-output ratio, 5V square wave output. Reserved pins for all other feedbacks.

AUX. COMM - USB Communication Connector

Pin	Name	Description / Notes	I/O
1	VBUS	Supply Voltage	O
2	DATA -	Data -	I/O
3	DATA +	Data +	I/O
4	RESERVED	-	-
5	USB GND	USB Ground	UGND

POWER - Power Connector

Pin	Name	Description / Notes	I/O
1	MOTOR A	Motor Phase A	O
2	MOTOR B	Motor Phase B	O
3	MOTOR C	Motor Phase C	O
4	SHIELD	Motor feedback cable shield. Internally connected to protective earth ground.	-
5	PE	Protective Earth Ground	-
6	L1	AC Supply Input (Single Phase)	I
7	L2 (N)		I
8	DC+	Internal DC Bus Voltage. If using an external brake resistor, connect between this port and BR. For DC Supply operation, connect DC supply +HV IN to this port.	I
9	BR	External Brake Resistor Connection. If using an external brake resistor, connect between this port and DC+.	-
10	DC-	Internal DC Bus Voltage. For DC Supply operation, connect DC supply ground to this port.	I

+24V LOGIC - Logic Power Connector

Pin	Name	Description / Notes	I/O
1	LOGIC GND	Logic Supply Ground (Common with Signal Ground)	GND
2	LOGIC PWR	Logic Supply Input	I

STO – Safe Torque Off Connector

Pin	Name	Description / Notes	I/O
1	STO OUTPUT	Safe Torque Off Output	O
2	RESERVED	Reserved	-
3	STO-1 RETURN	Safe Torque Off 1 Return	STORET1
4	STO-1	Safe Torque Off – Input 1	I
5	STO-2 RETURN	Safe Torque Off 2 Return	STORET2
6	STO-2	Safe Torque Off – Input 2	I
7	RESERVED	Reserved	-
8	STO OUT RETURN	Safe Torque Off Output Return	STORETO

HARDWARE SETTINGS

Network IP Address Switches

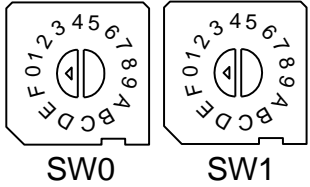
Switch Diagram	Description																								
 <p>SW0 SW1</p>	<p>Hexadecimal switch settings correspond to the last octet of the IP Address of the drive within the Ethernet network. Note that for POWERLINK, the IP address will always be 192.168.100.xxx.</p> <table border="1" style="margin-left: auto; margin-right: auto;"> <thead> <tr> <th style="text-align: center;">SW1</th> <th style="text-align: center;">SW0</th> <th style="text-align: center;">Node ID</th> </tr> </thead> <tbody> <tr> <td style="text-align: center;">0</td> <td style="text-align: center;">0</td> <td style="text-align: center;">Address stored in NVM</td> </tr> <tr> <td style="text-align: center;">0</td> <td style="text-align: center;">1</td> <td style="text-align: center;">001</td> </tr> <tr> <td style="text-align: center;">0</td> <td style="text-align: center;">2</td> <td style="text-align: center;">002</td> </tr> <tr> <td style="text-align: center;">...</td> <td style="text-align: center;">...</td> <td style="text-align: center;">...</td> </tr> <tr> <td style="text-align: center;">F</td> <td style="text-align: center;">D</td> <td style="text-align: center;">253</td> </tr> <tr> <td style="text-align: center;">F</td> <td style="text-align: center;">E</td> <td style="text-align: center;">254</td> </tr> <tr> <td style="text-align: center;">F</td> <td style="text-align: center;">F</td> <td style="text-align: center;">255</td> </tr> </tbody> </table>	SW1	SW0	Node ID	0	0	Address stored in NVM	0	1	001	0	2	002	F	D	253	F	E	254	F	F	255
SW1	SW0	Node ID																							
0	0	Address stored in NVM																							
0	1	001																							
0	2	002																							
...																							
F	D	253																							
F	E	254																							
F	F	255																							

LED Functions (on RJ-45 Communication Connectors)

LINK LED	
LED State	Description
Green – On	Valid Link - No Activity
Green – Flickering	Valid Link - Network Activity
Off	Invalid Link

Safe Torque Off (STO) Inputs

The Safe Torque Off (STO) Inputs are dedicated +24VDC max sinking single-ended inputs. A dedicated STO Disable Key connector is included and should be installed for applications where STO is not required.

MECHANICAL INFORMATION

COMM - Ethernet Communication Connector

Connector Information		Shielded, dual RJ-45 socket with LEDs
Mating Connector	Details	Standard CAT 5e or CAT 6 ethernet cable
	Included with Drive	No

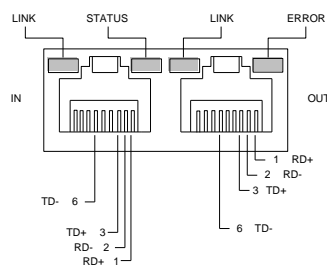

I/O - Signal Connector

Connector Information		26-pin, high-density, female D-sub
Mating Connector	Details	TYCO: Plug P/N 1658671-1; Housing P/N 5748677-3; Terminals P/N 1658670-2 (loose) or 1658670-1 (strip)
	Included with Drive	No

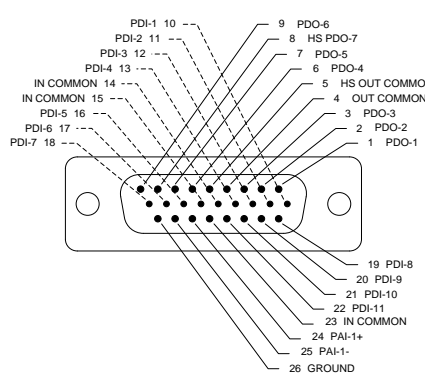

FEEDBACK - Feedback Connector

Connector Information		15-pin, high-density, female D-sub
Mating Connector	Details	TYCO: Plug P/N 748364-1; Housing P/N 5748677-2; Terminals P/N 1658670-2 (loose) or 1658670-1 (strip)
	Included with Drive	No

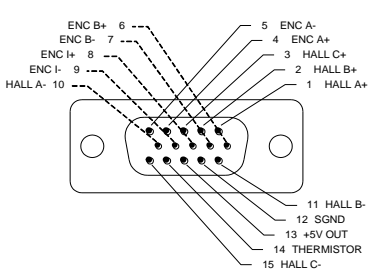

Incremental Encoder

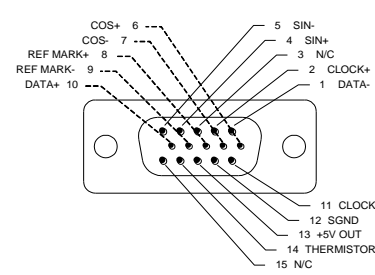

Absolute Encoder

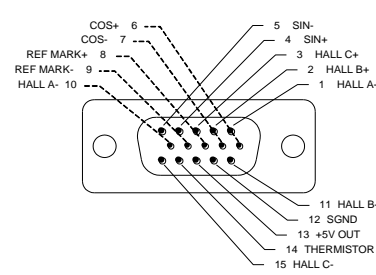

1Vp-p Sin/Cos Encoder

AUX. ENCODER - Auxiliary Feedback Connector

Connector Information	15-pin, high-density, male D-sub	
Mating Connector	Details	TYCO: Plug P/N 1658681-1; Housing P/N 5748677-2; Terminals P/N 1658686-2 (loose) or 1658686-1 (strip)
	Included with Drive	No

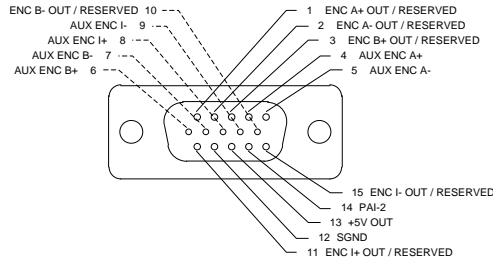

AUX. COMM – USB Communication Connector

Connector Information	5-pin, Mini USB B Type port	
Suggested Mating Cable	Details	TYCO: 1496476-3 (2-meter STD-A to MINI-B ASSY)
	Included with Drive	No

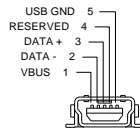

POWER - Power Connector

Connector Information	10-port, 5.08 mm spaced, enclosed, friction lock header	
Mating Connector	Details	Phoenix Contact: P/N 1781069
	Included with Drive	Yes

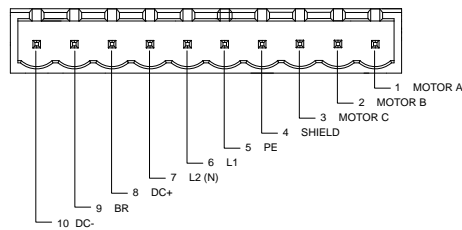

+24V LOGIC - Logic Power Connector

Connector Information	2-port, 3.5 mm spaced insert connector	
Mating Connector	Details	Phoenix Contact: P/N 1840366
	Included with Drive	Yes

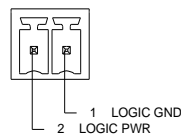

STO – Safe Torque Off Connector

Connector Information		8-port, 2.00 mm spaced, enclosed, friction lock header
Mating Connector	Details	Molex: P/N 511110-0860 (housing); 50394-8051 (pins)
	Included with Drive	Yes

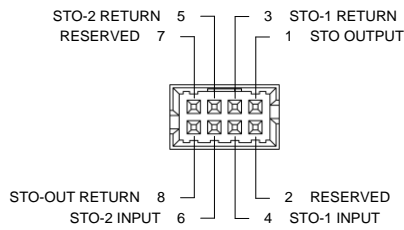

MOUNTING DIMENSIONS

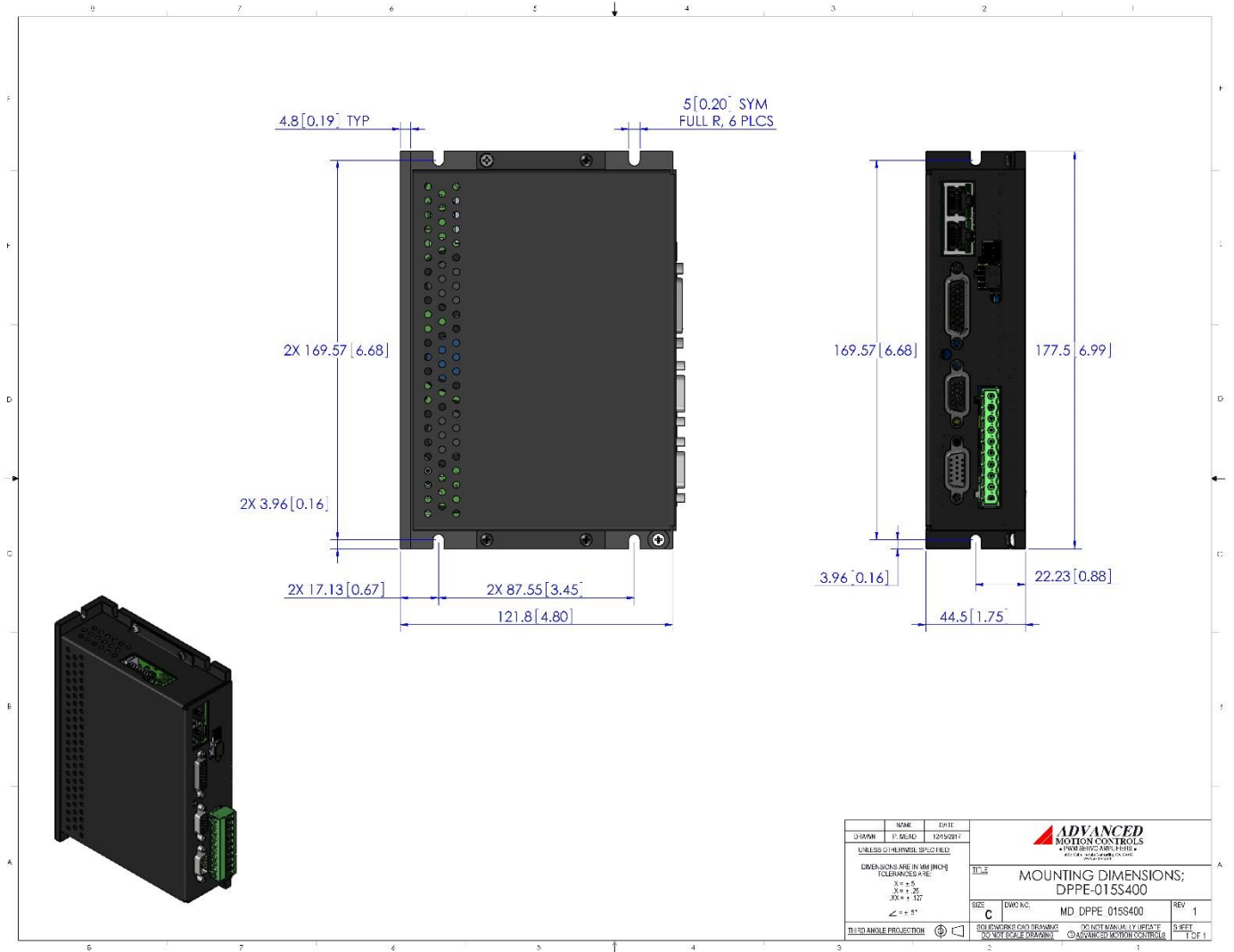

PART NUMBERING INFORMATION

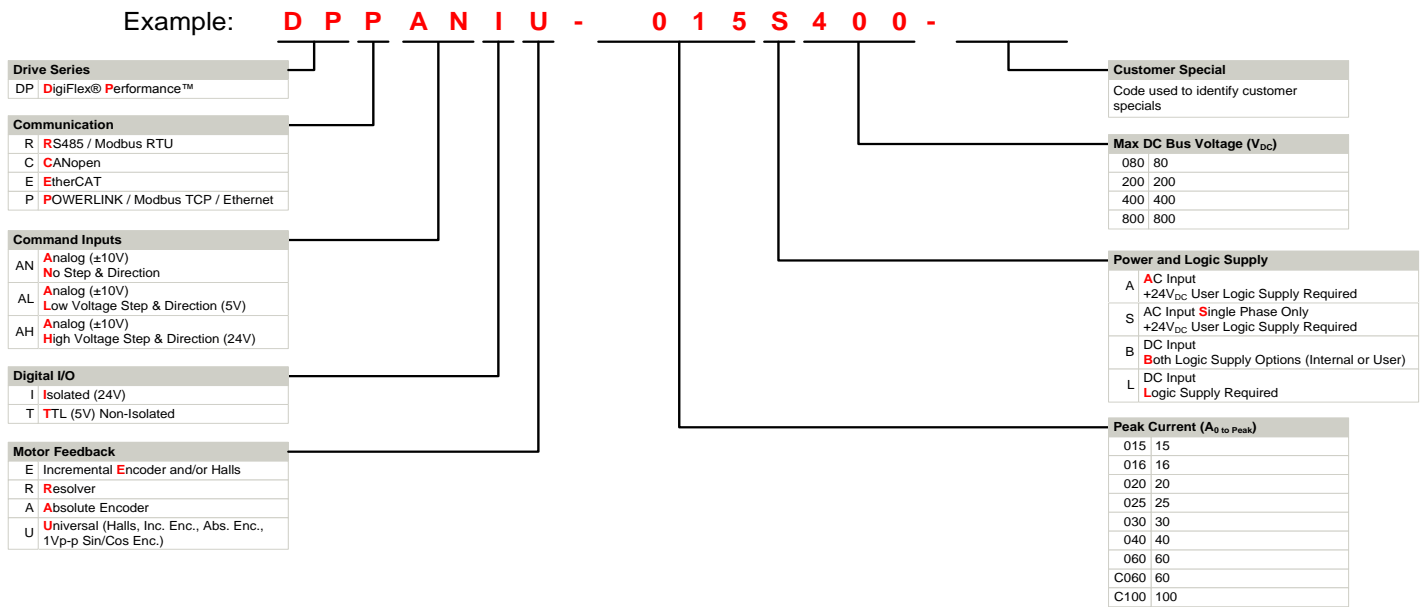

DigiFlex® Performance™ series of products are available in many configurations. All models listed in the selection tables of the website are readily available, standard product offerings.

ADVANCED Motion Controls also has the capability to promptly develop and deliver specified products for OEMs with volume requests. Our Applications and Engineering Departments will work closely with your design team through all stages of development in order to provide the best servo drive solution for your system. Equipped with on-site manufacturing for quick-turn customs capabilities, ADVANCED Motion Controls utilizes our years of engineering and manufacturing expertise to decrease your costs and time-to-market while increasing system quality and reliability. Feel free to contact Applications Engineering for further information and details.

Examples of Customized Products

- ▲ Optimized Footprint
- ▲ Private Label Software
- ▲ OEM Specified Connectors
- ▲ No Outer Case
- ▲ Increased Current Resolution
- ▲ Increased Temperature Range
- ▲ Custom Control Interface
- ▲ Integrated System I/O
- ▲ Tailored Project File
- ▲ Silkscreen Branding
- ▲ Optimized Base Plate
- ▲ Increased Current Limits
- ▲ Increased Voltage Range
- ▲ Conformal Coating
- ▲ Multi-Axis Configurations
- ▲ Reduced Profile Size and Weight

Available Accessories

ADVANCED Motion Controls offers a variety of accessories designed to facilitate drive integration into a servo system. Visit www.a-m-c.com to see which accessories will assist with your application design and implementation.



All specifications in this document are subject to change without written notice. Actual product may differ from pictures provided in this document.