

**Description**

The DigiFlex® Performance™ (DP) Series digital servo drives are designed to drive brushed and brushless servomotors. These fully digital drives operate in torque, velocity, or position mode and employ Space Vector Modulation (SVM), which results in higher bus voltage utilization and reduced heat dissipation compared to traditional PWM. The drive can be configured for a variety of external command signals. Commands can also be configured using the drive's built-in Motion Engine, an internal motion controller used with distributed motion applications. In addition to motor control, these drives feature dedicated and programmable digital and analog inputs and outputs to enhance interfacing with external controllers and devices.

This DP Series drive features an EtherCAT® interface for network communication using CANopen over EtherCAT (CoE), and a USB port for drive setup and commissioning using DriveWare® 7, available for download at [www.a-m-c.com](http://www.a-m-c.com).

All drive and motor parameters are stored in non-volatile memory. The DPE Series Hardware Installation Manual is available for download at [www.a-m-c.com](http://www.a-m-c.com).

**Power Range**

Peak Current	20 A (14.1 A <sub>RMS</sub> )
Continuous Current	10 A (10 A <sub>RMS</sub> )
Supply Voltage	20 - 80 VDC



**Features**

- ▲ CoE – Based on DSP-402 Device Profile for Drives and Motion Control
- ▲ Synchronization using Distributed Clocks
- ▲ Position Cycle Times down to 100µs
- ▲ Four Quadrant Regenerative Operation
- ▲ Space Vector Modulation (SVM) Technology
- ▲ Fully Digital State-of-the-art Design
- ▲ Programmable Gain Settings
- ▲ Fully Configurable Current, Voltage, Velocity and Position Limits
- ▲ PIDF Velocity Loop
- ▲ PID + FF Position Loop
- ▲ Compact size, high power density
- ▲ 16-bit Analog to Digital Hardware
- ▲ Built-in brake/shunt regulator
- ▲ On-the-Fly Mode Switching
- ▲ On-the-Fly Gain Set Switching

**MODES OF OPERATION**

- Profile Current
- Profile Velocity
- Profile Position
- Cyclic Synchronous Current Mode
- Cyclic Synchronous Velocity Mode
- Cyclic Synchronous Position Mode

**COMMAND SOURCE**

- ±10 V Analog
- Encoder Following
- Over the Network
- Sequencing
- Indexing
- Jogging

**FEEDBACK SUPPORTED (FIRMWARE DEPENDENT)**

- Halls
- Incremental Encoder
- Absolute Encoder (EnDat® 2.1/2.2, Hiperface®, or BiSS C-Mode)
- 1Vp-p Sine/Cosine Encoder
- Auxiliary Incremental Encoder
- Tachometer (±10 VDC)

**INPUTS/OUTPUTS**

- 1 Motor Thermistor/Switch Input
- 11 General Purpose Programmable Digital Inputs
- 6 General Purpose Programmable Digital Outputs
- 1 High Speed Programmable Digital Output
- 2 Programmable Analog Inputs



**COMPLIANCES & AGENCY APPROVALS**

- UL
- cUL
- CE Class A (LVD)
- CE Class A (EMC)
- RoHS II

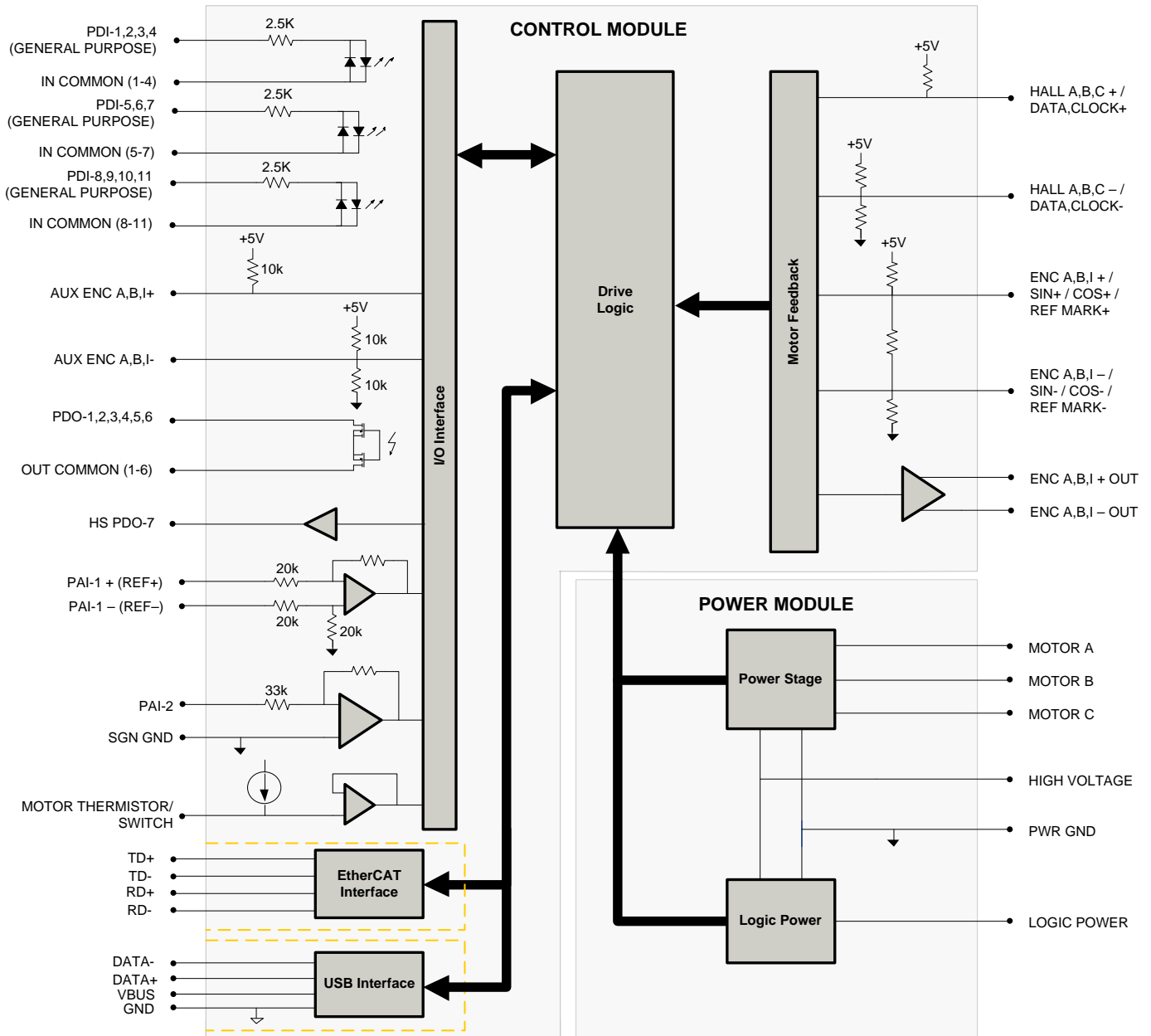
**BLOCK DIAGRAM**



**Information on Approvals and Compliances**

	<p>US and Canadian safety compliance with UL 508c, the industrial standard for power conversion electronics. UL registered under file number E140173. Note that machine components compliant with UL are considered UL registered as opposed to UL listed as would be the case for commercial products.</p>
	<p>Compliant with European EMC Directive 2004/108/EC on Electromagnetic Compatibility (specifically EN 61000-6-4:2007/A1:2011 for Emissions, Class A and EN 61000-6-2:2005 for Immunity, Performance Criteria A). LVD requirements of Directive 2006/95/EC (specifically, EN 60204-1:2006/A1:2009, a Low Voltage Directive to protect users from electrical shock).</p>
	<p>The RoHS II Directive 2011/65/EU restricts the use of certain substances including lead, mercury, cadmium, hexavalent chromium and halogenated flame retardants PBB and PBDE in electronic equipment.</p>

**SPECIFICATIONS**

Power Specifications			
Description	Units	Value	
DC Supply Voltage Range	VDC	20 – 80	
DC Bus Over Voltage Limit	VDC	88.3	
DC Bus Under Voltage Limit	VDC	17.5	
Logic Supply Voltage	VDC	20 - 80	
Maximum Peak Output Current <sup>1</sup>	A ( $A_{RMS}$ )	20 (14.1)	
Maximum Continuous Output Current <sup>2</sup>	A ( $A_{RMS}$ )	10 (10)	
Maximum Continuous Output Power	W	760	
Maximum Power Dissipation at Continuous Current	W	40	
Internal Bus Capacitance	µF	33	
Minimum Load Inductance (Line-To-Line) <sup>3</sup>	µH	600	
Switching Frequency	kHz	20	
Maximum Output PWM Duty Cycle	%	85	
Low Voltage Supply Outputs	-	+5 VDC (250 mA)	
Control Specifications			
Description	Units	Value	
Communication Interfaces <sup>4</sup>	-	EtherCAT® (USB for Configuration)	
Command Sources	-	±10 V Analog, Encoder Following, Over the Network, Sequencing, Indexing, Jogging	
Feedback Supported	-	Halls, Incremental Encoder, Absolute Encoder (EnDat® 2.1/2.2, Hiperface®, or BiSS C-Mode), 1Vp-p Sine/Cosine Encoder, Auxiliary Incremental Encoder, Tachometer (±10 VDC)	
Commutation Methods	-	Sinusoidal, Trapezoidal	
Modes of Operation	-	Profile Current, Profile Velocity, Profile Position, Cyclic Synchronous Current, Cyclic Synchronous Velocity, Cyclic Synchronous Position	
Motors Supported	-	Three Phase Brushless (Servo, Closed Loop Vector, Closed Loop Stepper), Single Phase (Brushed, Voice Coil, Inductive Load)	
Hardware Protection	-	40+ Configurable Functions, Over Current, Over Temperature (Drive & Motor), Over Voltage, Short Circuit (Phase-Phase & Phase-Ground), Under Voltage	
Programmable Digital Inputs/Outputs (PDIs/PDOs)	-	11/7	
Programmable Analog Inputs/Outputs (PAIs/PAOs)	-	2/0	
Primary I/O Logic Level	-	24 VDC	
Current Loop Sample Time	µs	50	
Velocity Loop Sample Time	µs	100	
Position Loop Sample Time	µs	100	
Maximum Sin/Cos Encoder Frequency	kHz	200	
Maximum Sin/Cos Interpolation	-	2048 counts per sin/cos cycle	
Internal Shunt Regulator	-	No	
Internal Shunt Resistor	-	No	
Mechanical Specifications			
Description	Units	Value	
Agency Approvals	-	CE Class A (EMC), CE Class A (LVD), cUL, RoHS II, UL	
Size (H x W x D)	mm (in)	166.7 x 87.8 x 35.9 (6.6 x 3.5 x 1.4)	
Weight	g (oz)	496 (17.5)	
Heatsink (Base) Temperature Range <sup>5</sup>	°C (°F)	0 - 65 (32 - 149)	
Storage Temperature Range	°C (°F)	-40 - 85 (-40 - 185)	
Cooling System	-	Natural Convection	
Form Factor	-	Panel Mount	
AUX. COMM Connector	-	5-pin, Mini USB B Type port	
COMM Connector	-	Shielded, dual RJ-45 socket with LEDs	
FEEDBACK Connector	-	15-pin, high-density, female D-sub	
AUX. ENCODER Connector	-	15-pin, high-density, male D-sub	
I/O Connector	-	26-pin, high-density, female D-sub	
POWER Connector	-	6-pin, 3.96 mm spaced, friction lock header	

**Notes**

1. Capable of supplying drive rated peak current for 2 seconds with 10 second foldback to continuous value. Longer times are possible with lower current limits.
2. Continuous  $A_{RMS}$  value attainable when RMS Charge-Based Limiting is used.
3. Lower inductance is acceptable for bus voltages well below maximum. Use external inductance to meet requirements.
4. EtherCAT® is a registered trademark and patented technology, licensed by Beckhoff Automation GmbH, Germany.
5. Additional cooling and/or heatsink may be required to achieve rated performance.

**PIN FUNCTIONS**

COMM – EtherCAT Communication Connector – C1				
Pin	Name	Description / Notes		I/O
1	RD+	Receiver + (100Base-TX)		I
2	RD-	Receiver - (100Base-TX)		I
3	TD+	Transmitter + (100Base-TX)		O
4	RESERVED	-		-
5	RESERVED	-		-
6	TD-	Transmitter - (100Base-TX)		O
7	RESERVED	-		-
8	RESERVED	-		-
9	RESERVED	-		-

I/O – Signal Connector – C2				
Pin	Name	Description / Notes		I/O
1	PDO-1	General Purpose Programmable Digital Output (120 mA maximum)		O
2	PDO-2	General Purpose Programmable Digital Output (120 mA maximum)		O
3	PDO-3	General Purpose Programmable Digital Output (120 mA maximum)		O
4	OUT COMMON	Digital Output Common (1-6)		OCOM
5	GROUND	Ground		GND
6	PDO-4	General Purpose Programmable Digital Output (120 mA maximum)		O
7	PDO-5	General Purpose Programmable Digital Output (120 mA maximum)		O
8	HS PDO-7	High Speed Programmable Digital Output		O
9	PDO-6	General Purpose Programmable Digital Output (120 mA maximum)		O
10	PDI-1	General Purpose Programmable Digital Input		I
11	PDI-2	General Purpose Programmable Digital Input		I
12	PDI-3	General Purpose Programmable Digital Input		I
13	PDI-4	General Purpose Programmable Digital Input		I
14	IN COMMON	Digital Input Common (1-4)		ICOM
15	IN COMMON	Digital Input Common (5-7)		ICOM
16	PDI-5	General Purpose Programmable Digital Input		I
17	PDI-6	General Purpose Programmable Digital Input		I
18	PDI-7	General Purpose Programmable Digital Input		I
19	PDI-8	General Purpose Programmable Digital Input		I
20	PDI-9	General Purpose Programmable Digital Input		I
21	PDI-10	General Purpose Programmable Digital Input		I
22	PDI-11	General Purpose Programmable Digital Input		I
23	IN COMMON	Digital Input Common (8-11)		ICOM
24	PAI-1+	General Purpose Differential Programmable Analog Input or Reference Signal Input (16-bit Resolution)		I
25	PAI-1-			I
26	GROUND	Ground		GND

FEEDBACK – Feedback Connector – C3*					
Pin	Incremental Encoder	Absolute Encoder	1Vp-p Sin/Cos Encoder	Description / Notes	I/O
1	HALL A+	DATA-	HALL A+	Differential Hall A+ / Differential Data Line (BiSS: SLO-)	I
2	HALL B+	CLOCK+	HALL B+		Differential Hall B+ / Differential Clock Line (BiSS: MA+)
3	HALL C+	N/C	HALL C+	Differential Hall C+	I
4	ENC A+	SIN +	SIN +	Differential Encoder A / Differential Sine Input (Leave open for BiSS and EnDat 2.2)	I
5	ENC A-	SIN -	SIN -		I
6	ENC B+	COS +	COS +	Differential Encoder B / Differential Cosine Input (Leave open for BiSS and EnDat 2.2)	I
7	ENC B-	COS -	COS -		I
8	ENC I+	REF MARK+	REF MARK +	Differential Encoder Index / Differential Reference Mark (Leave open for BiSS and EnDat 2.2)	I
9	ENC I-	REF MARK-	REF MARK -		I
10	HALL A-	DATA+	HALL A-	Differential Hall A- / Differential Data Line (BiSS: SLO+)	I
11	HALL B-	CLOCK-	HALL B-	Differential Hall B- / Differential Clock Line (BiSS: MA-)	I
12	SGND	SGND	SGND	5V Return (Signal Ground)	SGND
13	+5V OUT	+5V OUT	+5V OUT	+5V Encoder Supply Output. Short-circuit protected. (250mA)	O
14	THERMISTOR	THERMISTOR	THERMISTOR	Motor Thermal Protection	I
15	HALL C-	N/C	HALL C-	Differential Hall C-	I

\*Note: Feedback supported (Incremental Encoder, Absolute Sin/Cos Encoder, or 1Vp-p Sin/Cos Encoder) will be dependent on firmware.

**AUX. ENCODER – Auxiliary Encoder Connector – C4**

Pin	Name	Description / Notes	I/O
1	ENC A+ OUT / RESERVED	Buffered Encoder Channel A Output* or Reserved.	O
2	ENC A- OUT / RESERVED		O
3	ENC B+ OUT / RESERVED	Buffered Encoder Channel B Output* or Reserved.	O
4	AUX ENC A+		I
5	AUX ENC A-	Auxiliary Encoder Input (For single ended signal leave negative terminal open)	I
6	AUX ENC B+		I
7	AUX ENC B-	Auxiliary Encoder Input (For single ended signal leave negative terminal open)	I
8	AUX ENC I+		I
9	AUX ENC I-	Auxiliary Encoder Index Input (For single ended signal leave negative terminal open)	I
10	ENC B- OUT / RESERVED		O
11	ENC I+ OUT / RESERVED	Buffered Encoder Index Output* or Reserved.	O
12	SGND	Signal Ground	SGND
13	+5V OUT	+5 VDC User Supply	O
14	PAI-2	Programmable Analog Input (12-bit Resolution)	I
15	ENC I- OUT / RESERVED	Buffered Encoder Index Output* or Reserved.	O

\*Buffered encoder output only available with incremental encoder or 1Vp-p sin/cos encoder feedbacks. 1:1 input-to-output ratio, 5V square wave output. Reserved pins for all other feedbacks.

**AUX. COMM - USB Communication Connector – C5**

Pin	Name	Description / Notes	I/O
1	VBUS	Supply Voltage	O
2	DATA -	Data -	I/O
3	DATA +	Data +	I/O
4	RESERVED	-	-
5	USB GND	USB Ground	UGND

**POWER - Power Connector**

Pin	Name	Description / Notes	I/O
1	MOTOR A	Motor Phase A	O
2	MOTOR B	Motor Phase B	O
3	MOTOR C	Motor Phase C	O
4	HIGH VOLTAGE	DC Power Input	I
5	PWR GND	Power Ground (Common With Signal Ground)	PGND
6	LOGIC PWR	Logic Supply Input	I

**HARDWARE SETTINGS**
**EtherCAT Station Alias Selector Switches**

Switch Diagram	Description																								
 SW0      SW1	Hexadecimal switch settings correspond to the drive Station Alias. Note that drives on an EtherCAT network will be given an address automatically based on proximity to the host. Setting the switches manually is optional, and only necessary if a fixed address is required.																								
	<table border="1"> <thead> <tr> <th>SW1</th> <th>SW0</th> <th>Node ID</th> </tr> </thead> <tbody> <tr> <td>0</td> <td>0</td> <td>Address stored in NVM</td> </tr> <tr> <td>0</td> <td>1</td> <td>001</td> </tr> <tr> <td>0</td> <td>2</td> <td>002</td> </tr> <tr> <td>...</td> <td>...</td> <td>...</td> </tr> <tr> <td>F</td> <td>D</td> <td>253</td> </tr> <tr> <td>F</td> <td>E</td> <td>254</td> </tr> <tr> <td>F</td> <td>F</td> <td>255</td> </tr> </tbody> </table>	SW1	SW0	Node ID	0	0	Address stored in NVM	0	1	001	0	2	002	...	...	...	F	D	253	F	E	254	F	F	255
SW1	SW0	Node ID																							
0	0	Address stored in NVM																							
0	1	001																							
0	2	002																							
...	...	...																							
F	D	253																							
F	E	254																							
F	F	255																							

**LED Functions (on RJ-45 Communication Connectors)**

LINK LED		
LED State	Description	
Green – On	Valid Link - No Activity	
Green – Flickering	Valid Link - Network Activity	
Off	Invalid Link	
STATUS LED		
LED State	Description	
Green – On	The device is in the state OPERATIONAL	
Green – Blinking (2.5Hz – 200ms on and 200ms off)	The device is in the state PRE-OPERATIONAL	
Green – Single Flash (200ms flash followed by 1000ms off)	The device is in state SAFE-OPERATIONAL	
Green – Flickering (10Hz – 50ms on and 50ms off)	The device is booting and has not yet entered the INIT state or The device is in state BOOTSTRAP or Firmware download operation in progress	
Off	The device is in state INIT	
ERROR LED		
LED State	Description	Example
Red – On	A PDI Watchdog timeout has occurred.	Application controller is not responding anymore.
Red – Blinking (2.5Hz – 200ms on and 200ms off)	General Configuration Error.	State change commanded by master is impossible due to register or object settings.
Red – Flickering (10Hz – 50ms on and 50ms off)	Booting Error was detected. INIT state reached, but parameter “Change” in the AL status register is set to 0x01:change/error	Checksum Error in Flash Memory.
Red – Single Flash (200ms flash followed by 1000ms off)	The slave device application has changed the EtherCAT state autonomously: Parameter “Change” in the AL status register is set to 0x01:change/error.	Synchronization error; device enters SAFE-OPERATIONAL automatically
Red – Double Flash (Two 200ms flashes separated by 200ms off, followed by 1000ms off)	An application Watchdog timeout has occurred.	Sync Manager Watchdog timeout.

**MECHANICAL INFORMATION**

**COMM - EtherCAT Communication Connector – C1**

Connector Information		Shielded, dual RJ-45 socket with LEDs
Mating Connector	Details	Standard CAT 5e or CAT 6 ethernet cable
	Included with Drive	No

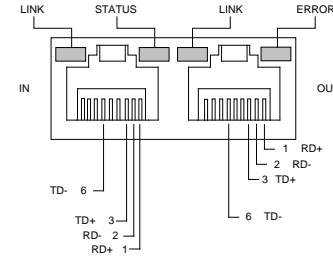

**I/O - Signal Connector – C2**

Connector Information		26-pin, high-density, female D-sub
Mating Connector	Details	TYCO: Plug P/N 1658671-1; Housing P/N 5748677-3; Terminals P/N 1658670-2 (loose) or 1658670-1 (strip)
	Included with Drive	No

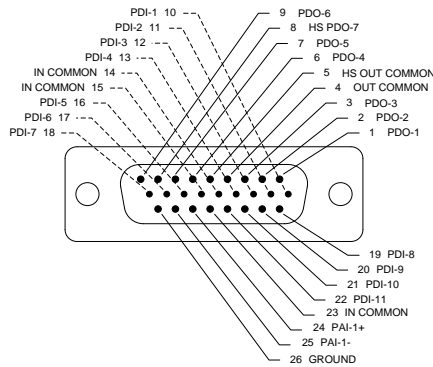

**FEEDBACK - Feedback Connector – C3**

Connector Information		15-pin, high-density, female D-sub
Mating Connector	Details	TYCO: Plug P/N 748364-1; Housing P/N 5748677-2; Terminals P/N 1658670-2 (loose) or 1658670-1 (strip)
	Included with Drive	No

**Incremental Encoder**

**Absolute Encoder**

**1Vp-p Sin/Cos Encoder**

**AUX. ENCODER - Auxiliary Feedback Connector – C4**

Connector Information		15-pin, high-density, male D-sub
Mating Connector	Details	TYCO: Plug P/N 1658681-1; Housing P/N 5748677-2; Terminals P/N 1658686-2 (loose) or 1658686-1 (strip)
	Included with Drive	No

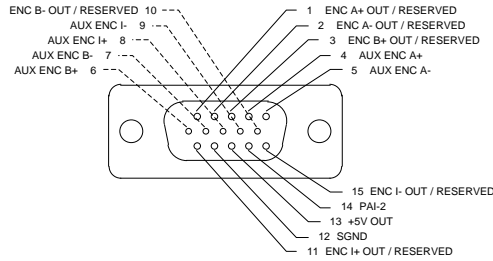

**AUX. COMM – USB Communication Connector – C5**

Connector Information		5-pin, Mini USB B Type port
Suggested Mating Cable	Details	TYCO: 1496476-3 (2-meter STD-A to MINI-B ASSY)
	Included with Drive	No

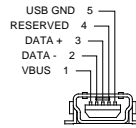

**POWER - Power Connector**

Connector Information		6-pin, 3.96 mm spaced, friction lock header
Mating Connector	Details	AMP: Plug P/N 770849-6; Terminals P/N 770522-1 (loose) or 770476-1 (strip)
	Included with Drive	Yes

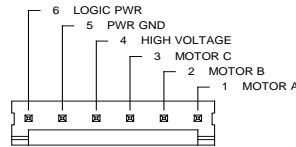



**MOUNTING DIMENSIONS**

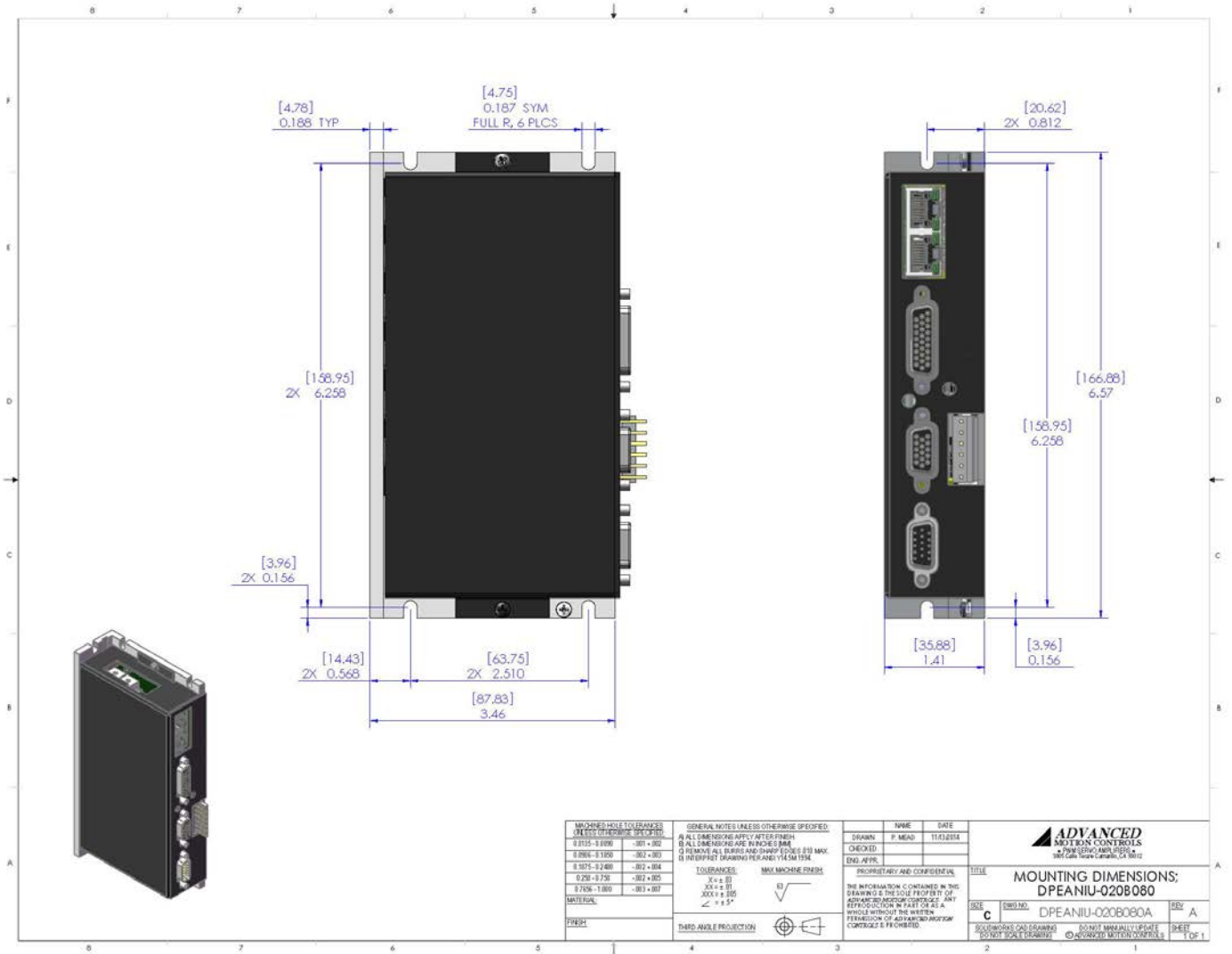

**PART NUMBERING INFORMATION**

Example: **D P E A N I U - 0 2 0 B 0 8 0 -**

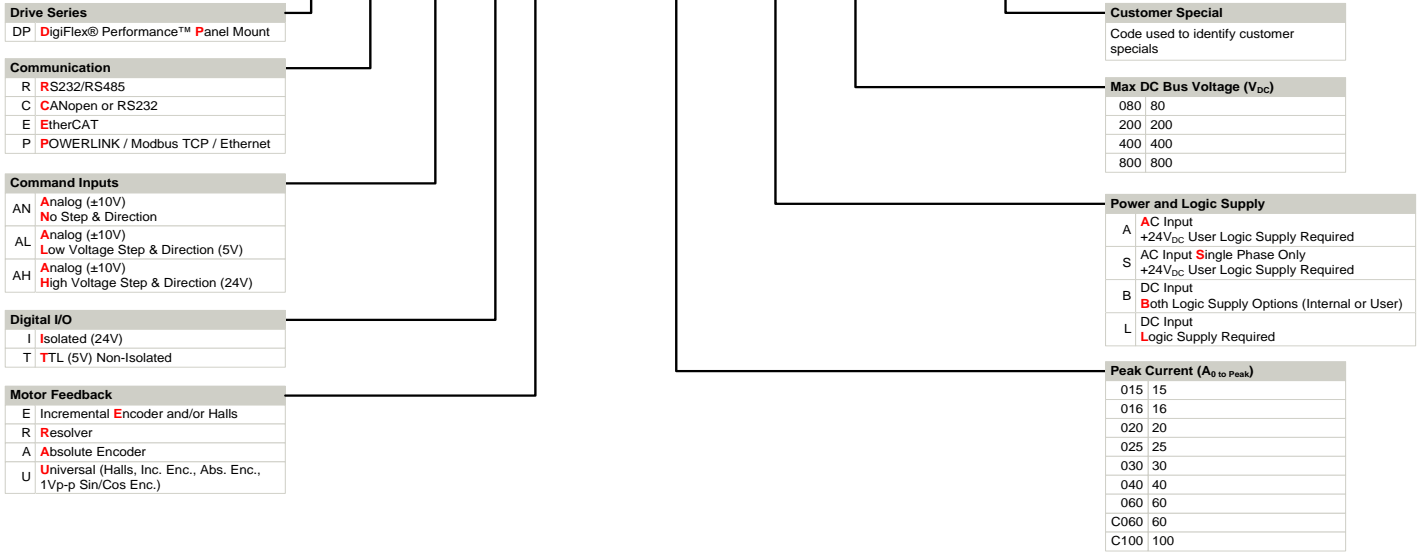

DigiFlex® Performance™ series of products are available in many configurations. Note that not all possible part number combinations are offered as standard drives. All models listed in the selection tables of the website are readily available, standard product offerings.

ADVANCED Motion Controls also has the capability to promptly develop and deliver specified products for OEMs with volume requests. Our Applications and Engineering Departments will work closely with your design team through all stages of development in order to provide the best servo drive solution for your system. Equipped with on-site manufacturing for quick-turn customs capabilities, ADVANCED Motion Controls utilizes our years of engineering and manufacturing expertise to decrease your costs and time-to-market while increasing system quality and reliability. Feel free to contact Applications Engineering for further information and details.

**Examples of Customized Products**

- ▲ Optimized Footprint
- ▲ Private Label Software
- ▲ OEM Specified Connectors
- ▲ No Outer Case
- ▲ Increased Current Resolution
- ▲ Increased Temperature Range
- ▲ Custom Control Interface
- ▲ Integrated System I/O
- ▲ Tailored Project File
- ▲ Silkscreen Branding
- ▲ Optimized Base Plate
- ▲ Increased Current Limits
- ▲ Increased Voltage Range
- ▲ Conformal Coating
- ▲ Multi-Axis Configurations
- ▲ Reduced Profile Size and Weight

**Available Accessories**

ADVANCED Motion Controls offers a variety of accessories designed to facilitate drive integration into a servo system. Visit [www.a-m-c.com](http://www.a-m-c.com) to see which accessories will assist with your application design and implementation.



All specifications in this document are subject to change without written notice. Actual product may differ from pictures provided in this document.